

FASDEK[®] 快易安

波紋式屋面系統

Corrugated Roof System

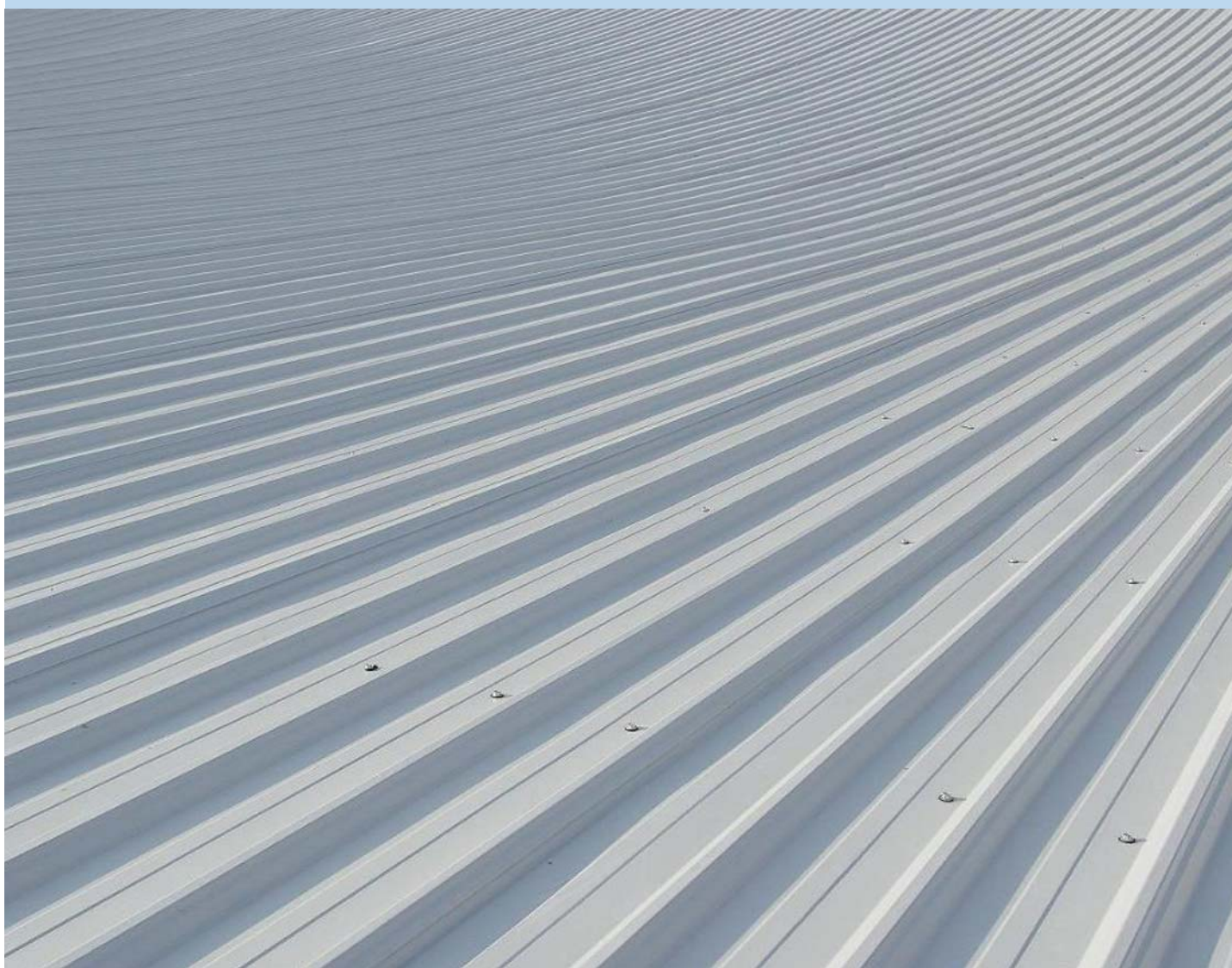

建築金屬圍護 全方位服務

SOLUTION Provider of Metal Building Envelope

目錄 Contents

Products			
1 .	產品簡介		
	1.1	Profile 板型	1
	1.2	Materials 材料	2
	1.3	Surface Treatment 表面處理	2
	1.4	Features 板型特性	3
	1.5	Standard System 標準系統	4
	1.6	System Recommendation 系統推薦	6
Performance			
2 .	性能介紹		
	2.1	Durability 耐久性能	7
	2.2	Wind Resistance 抗風性能	9
	2.3	Water proof 防水性能	11
	2.4	Fire Resistance 耐火性能	13
Details			
3 .	系統節點		
	3.1	Gable details 山牆節點	15
	3.2	Ridge details 屋脊節點	16
	3.3	Expansion Joint 伸縮縫節點	17
	3.4	Step Slope 坡度節點	17
	3.5	Gutter details 天溝節點	18
	3.6	Skylight details 天窗節點	18
Projects			
4 .	工程案例		
	4.1	Projects 工程案例	19

建築金屬圍護 全方位服務

SOLUTION Provider of Metal Building Envelope

產品簡介

1 . Products

1.1 FASDEK Panel Profile 快易安板型

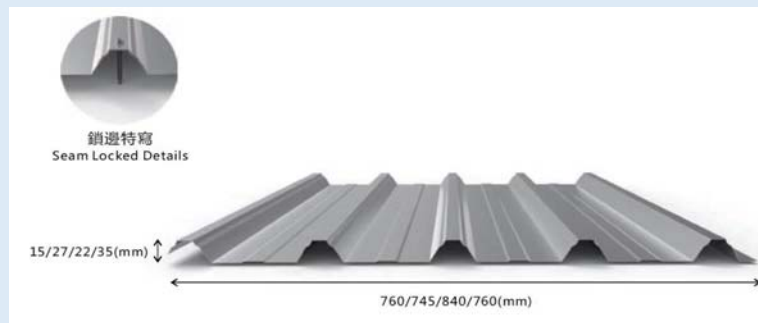

FASDEK 快易安為傳統波浪壓型板改良而成，結構功能直接可靠，外牆簡潔明快；作用正反弧型屋面材料時，可因建築設計要求，選用合適材料，配用不同的成弧加工方法達到設計效果（成弧加工方法包括板長自重成弧、使用輓彎機械輓壓成弧及使用液壓機械模具壓成弧）；應用範圍廣泛，可做屋面、外牆、天花、底板等多功能用途。

FASDEK is improved from traditional wave-pressure plate and can choose the right multi-curved materials matching different curving processing to meet design requirements. (Processing includes length-weight curving, rolling curving, hydraulic machinery curving, etc).

FASDEK can be applied in roofing, exterior wall, ceiling, decking, etc.

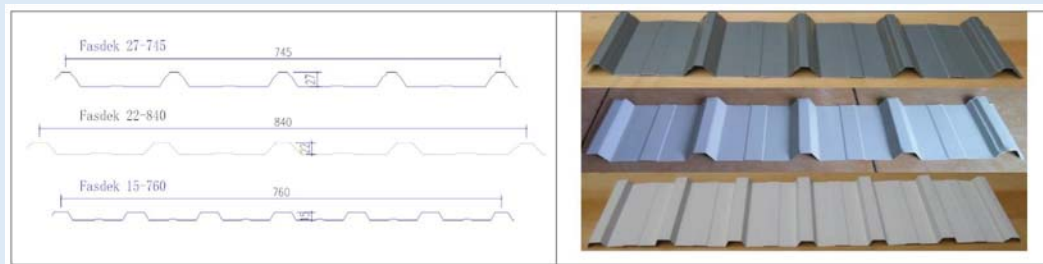

建築金屬圍護 全方位服務

SOLUTION Provider of Metal Building Envelope

產品簡介

1 . Products

1.2 面板材料 Panel Materials

FASDEK 快易安全屬屋面可以提供不鏽鋼、鋁合金、彩鋼板等材質供設計師根據項目個性需要自由選擇。

FASDEK roof can provide Stainless steel, Aluminum alloy, Paint steel and other materials for designers to choose freely according to the individual needs of the project.

不鏽鋼 Stainless Steel	SUS 316L	SUS 445
鋁合金 Aluminum Alloy	AA 3004	AA5052
彩鋼板 Painted Steel	AM/AZ 150 G550	

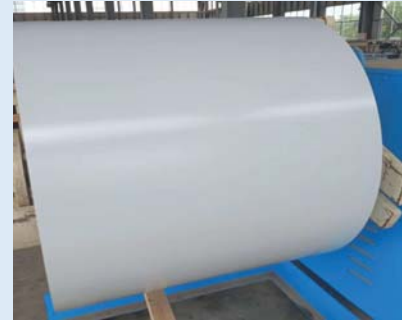

材料類別 Materials	厚度 mm Thickness	耐腐蝕性 Corrosion Assistance	熱膨脹性 Expansion	耐海洋氣候 Ocean Climate Resistant
不鏽鋼 316L Stainless steel	0.4~0.7	○○○○○	○○○	○○○○○
不鏽鋼445 Stainless steel	0.4~0.7	○○○○○	○○	○○○
不鏽鋼444 (烤漆) Stainless steel	0.4~0.7	○○○○○	○○	○○○
鋁合金 3004 Aluminum alloy	0.7~1.2	○○○	○	○○
鋁合金 5052 Aluminum Alloy	0.7~1.2	○○	○	○○
彩鋼板 Paint steel	0.4~0.7	○	○○	○

注：○ 是代表性能的優異程度。 Note: ○ is the performance level.

1.3 表面處理 Surface Treatment

* 壓紋 Embossing

不鏽鋼材質的屋面板可以在表面，附加不同形式的壓紋，對光線造成漫射，產生柔和舒適的外觀效果。

The stainless steel roof panel can be embossed in different forms on the surface to diffuse the light and produce a soft and comfortable appearance.



防反光
Anti-Reflective

* 烤漆 Painting

除了壓紋工藝外，金屬屋面板還可以選擇表面烤漆處理，可以滿足不同建築設計顏色的需求。(僅限鐵素體444不鏽鋼)

In addition to the embossing process, the Roof panel can also choose the surface paint treatment, which can meet the needs of different architectural design colors. (Ferritic 444 stainless steel only)

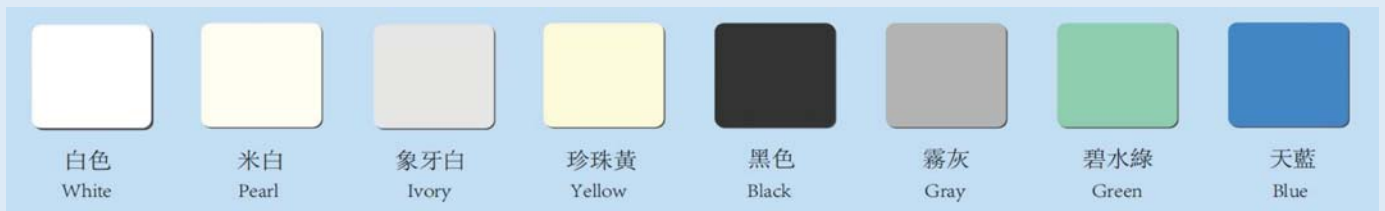

建築金屬圍護 全方位服務

SOLUTION Provider of Metal Building Envelope

產品簡介

1 . Products

1.4 板型特性 Features

FASDEK 快易安屋面系統產品具有多樣特點，可以滿足設計複雜，應用多變要求，融入現代建築理念。

FASDEK roof system products have various characteristics, which can meet the requirements of complex designs and changeable applications, and are easy integrated into modern architectural concepts.



在異型、彎弧屋面板的應用過程中，板肋變形是最常見的問題而且影響屋面結構性能，因此應通過檢測來確定產品截面特性並用於設計驗算，產品系統測試所用的異型板、彎弧板的形狀大小等特徵是需要和項目建設一致。

In the application process of special-shaped and curved roof panels, the deformation of plate ribs is the most common problem and affects the performance of the roof structure. Therefore, the cross-sectional characteristics of the product should be determined through testing and used for design verification. The shape and size of the special-shaped plate and the curved plate used in the product system test need to be consistent with the project construction.

建築金屬圍護 全方位服務

SOLUTION Provider of Metal Building Envelope

產品簡介

1 . Products

1.5 標準系統組合 Standard System

FASDEK 快易安可以根據不同建築使用需求，自由搭配或不同的系統屋面產品。
According to the different requirements, FASDEK can be combined with different roof products freely.

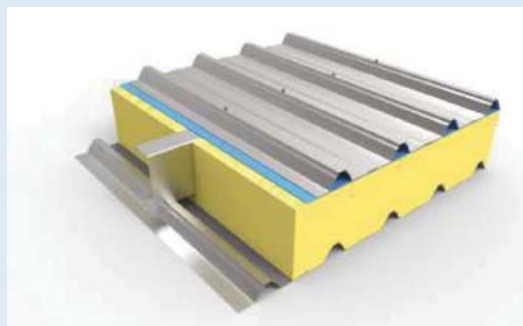

A 款 : 標條結構系統-1
Type A : Purlin Structure-1

標條結構，性價比高，底面美觀，可做天花使用

Purlin structure, high cost performance, beautiful bottom surface, can be used as ceiling.

性能指標 Performance Indicators

設計使用年限 Design life	50年 +
耐火系數 Fire resistance	>1.5 H
抗風荷載 wind load resistance	8.0 kPa
系統自重 System Weight	0.3kN/m ² ~0.4kN/m ²
系統厚度 Thickness	~200mm

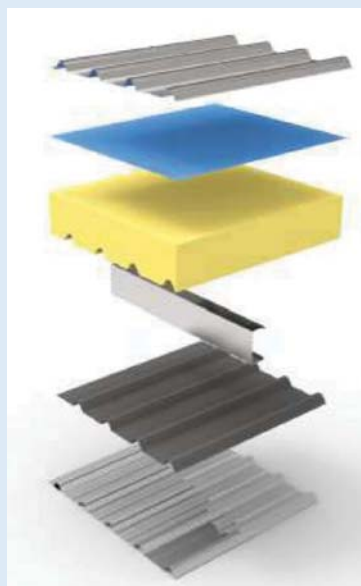

系統構造 Components

由上至下 From top to bottom

- A : 快易安面板 FASDEK Roof panel
- B : 防水透氣膜 Breather membranes
- C : 優質岩棉 Rock wool insulation
- D : 鍍鋅鋼標條 Galv. steel Purlin
- E : 隔氣膜 Vapour control layer
- F : 快易安底板 FASDEK Liner sheet

建築金屬圍護 全方位服務

SOLUTION Provider of Metal Building Envelope

產品簡介

1 . Products

1.5 標準系統組合 Standard System

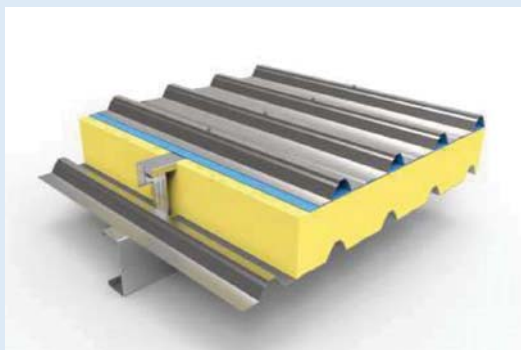

B 款 : 標條結構系統-2
Type B : Purlin Structure-2

經典標條結構，經濟性價比高

Classical Purlin Structure With High Economic Speciality

性能指標 Performance Indicators

設計使用年限 Design life	50年 +
耐火系數 Fire resistance	>1.5 H
抗風荷載 wind load resistance	8.0 kPa
系統自重 System Weight	0.3kN/m ² ~0.4kN/m ²
系統厚度 Thickness	~180mm +

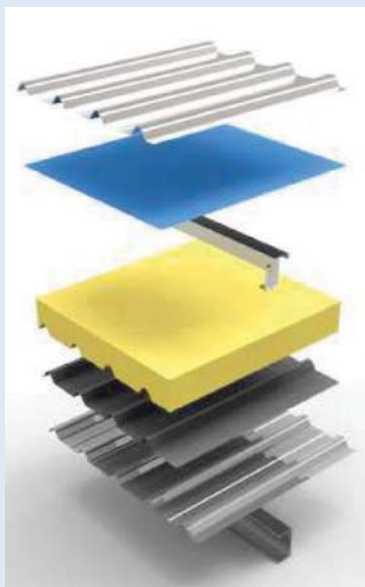

系統構造 Components

由上至下 From top to bottom

- A : 快易安面板 FASDEK Roof panel
- B : 防水透氣膜 Breather membranes
- C : 輕而固內支撐 Fasgrip support
- D : 優質岩棉 Rock wool insulation
- E : 隔氣膜 Vapour control layer
- F : 快易安底板 FASDEK Liner sheet
- G : 鍍鋅鋼標條 Galv. steel Purlin

建築金屬圍護 全方位服務

SOLUTION Provider of Metal Building Envelope

產品簡介

1 . Products

1.6 System Recommendation 系統推薦

P&L百安力將與設計師密切溝通，了解建築設計階段的要求細節，並根據專案特點提供科學合理的屋面系統。

P&L will communicate closely with the designer to understand the details of the requirements in the architectural design stage, and provide a scientific and reasonable roofing system according to the characteristics of the project.

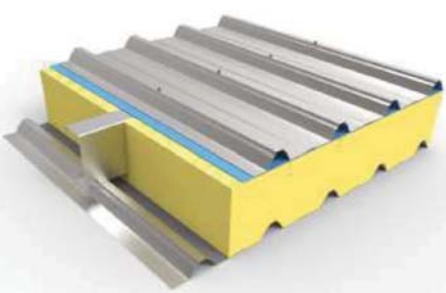
項目概況 Project Introduction		設計 Design Services (No.1)			
建築類型/功能 : Building function	1. 展覽會館 Exhibition	2. 體育中心 Stadium	3. 飛機場 Airport	4. 火車站 Train station	5. 其他 Other
建築使用壽命 Service life	5年(臨時性) 5 years	25年(易於替換性) 25 years	50年(普通房屋) 50 years	100年(新概念建築) 100 years	
建築性能要求: Requirements	外觀性能 Appearance	造型較為複雜, 曲面較多。 Complex surface.			
	耐久性能 Durability	建築位於亞熱帶沿海地區, 海洋性腐蝕環境。 Subtropical coastal areas, marine corrosive environment.			
	保溫性能 Insulation	需要冬季保溫, 夏季隔熱。 Requires insulation in winter and summer.			
	聲學性能 Acoustic	無特殊要求。 No special requirements.			
	抗風性能 Wind resistance	符合MCIS標準要求。設計風壓5.0kpa以上。 Meets MCIS standard requirements. Design wind pressure above 5.0kpa.			
	防水性能 Waterproofing	優異的防水排水性能。 Excellent waterproof and drainage performance.			
	耐火性能 Fire Resistance	符合BS476. EN1187標準耐火要求。 Comply with BS476. EN1187 standard fire resistance requirements.			
	底板/天花性能 Tray/Ceiling	底面平整美觀, 無需加裝天花。 The base is flat and beautiful, no need to install a ceiling.			
廠家建議 Recommendation					
		<p>A : 快易安面板 FASDEK Roof panel</p> <p>B : 防水透氣膜 Breather membranes</p> <p>C : 優質岩棉 Rock wool insulation</p> <p>D : 鍍鋅鋼標條 Galv. steel Purlin</p> <p>E : 隔氣膜 Vapour control layer</p> <p>F : 快易安底板 FASDEK Liner sheet</p>			
性能指標 Performance Indicators					
外觀性能 Appearance	良好成弧性能 Good arc forming performance	抗風性能 Wind resistance	動態抗風性能達到 $\geq 8.0kpa$ Dynamic wind resistance (MCIS)		
耐久性能 Durability	系統設計使用年限50年以上 System design life more than 50 years	防水性能 Waterproofing	15分鐘噴淋, 無滲漏 (MCIS) 15 minutes spray, no leakage (MCIS)		
保溫性能 Insulation	熱傳導係數 Thermal conductivity 0.35W/(m ² ·K) 表面溫度係數 Surface temp. coefficient 0.9	耐火性能 Fire Resistance	90min 無穿透、融化、滴落 No penetration, melting, drip (BS. EN)		
聲學性能 Acoustic	計權隔聲量 37dB Weighted sound insulation 37dB	底板/天花性能 Tray/Ceiling	底面平整美觀, 可直接做為天花使用 The base is smooth as a ceiling		

建築金屬圍護 全方位服務

SOLUTION Provider of Metal Building Envelope

性能介紹 2 . Performance

2.1 Durability 耐久性能

金屬屋面腐蝕 Metal Roof Corrosion:

金屬材料受周圍介質的作用而損壞，稱為金屬腐蝕。金屬的鏽蝕是最常見的腐蝕形態。這會顯著降低金屬材料的強度、塑性、韌性等力學性能，破壞金屬構件的幾何形狀，增加零件間的磨損，破壞了材質的物理性能，縮短建築的使用壽命。

The metal material is damaged by the action of the surrounding medium, known as metal corrosion. Rust, the most common form of corrosion, will significantly reduce the mechanical properties such as strength, plasticity, toughness, etc., damage the geometry of the metal components, increase wear between parts, destroy physical properties, and shorten the service life of the building.



不同的環境會對金屬帶來不同的腐蝕效果，所以屋面選材要根據不同的環境考慮。因此環境因素對於系統的耐久性能非常重要，而環境因素又包括了外部環境和內部環境。

The different environments will cause different metal corrosion. Thus, for materials durability, the environment effect, which including exterior and interior should be considered when selecting materials.

A 外部環境 Exterior :

◎ 海洋環境 Ocean

◎ 工業環境 Industry

◎ 鄉村和郊區環境 Village

B 內部環境 Interior:

◎ 潮溼或有污染的環境 Wet/polluted

◎ 乾燥的環境 Dry

◎ 熱/乾燥的環境 Hot / Dry

外部環境下不同材料的耐久性：

Durability of different materials in exterior environment:

自然材質，表面無有機塗層 Natural material, without coating

材質 Material	外部環境 External Environment		
	◎ 海洋環境 Ocean	◎ 工業環境 Industry	◎ 鄉村和郊區 Village
不銹鋼 Stainless Steel	> 50 years	> 50 years	> 50 years
鋁合金 Aluminum Alloy	> 10 years	> 10 years	> 25 years
熱浸鍍鋁鋅 Hot-Dip Al-zn	10 years	> 10 years	20 years
熱浸鍍鋅 Hot-Dip Zn	2-5 years	2-5 years	15 years

建築金屬圍護 全方位服務

SOLUTION Provider of Metal Building Envelope

性能介紹 2 . Performance

2.1 Durability 耐久性能

爲了增強金屬屋面的耐久性能,通常會對金屬屋面板進行預軋塗耐候性塗料,以下是不同材質的金屬板在中性鹽霧 2000小時測試後表面的腐蝕狀態:

In order to enhance the durability of metal roofs, the metal roof panels are usually pre-rolled with weather-resistant coatings. The following is the corrosion state of the metal panels of different materials after 2000 hours of neutral salt spray test:



AA 5052 彩鋁 5052 color aluminum

316不銹鋼 316 stainless steel

鋅鈦合金板 Zinc-titanium panel

因此,金屬屋面系統的設計應用應充分考慮耐久性特點,根據不同的建築壽命要求進行科學有效的金屬屋面系統設計和選材。如BS 7543:1992對於不同的建築有著不同的壽命要求。

Therefore, the design and application of metal roofing systems should fully consider the durability characteristics, and carry out scientific and effective design and material selection of metal roofing systems according to different building life requirements. For example, BS 7543:1992 has different life requirements for different buildings.

類別 Category	描述 Description	建築壽命 Service Life	示例 Example
1	臨時性的 Temporary	10年 10 years	臨時性的展廳和臨時性的場所建築 Temporary exhibition building
2	短期 short term	最少10年 10 + years	臨時性的教室,短期工業建築,倉庫等 Temporary classroom, industrial building warehouse etc
3	中期 Medium term	最少30年 30 + years	大多數的工業廠房 Most of industrial workshop
4	正常期限 Normal term	最少60年 60 + years	新建的教學樓、住宅等 New teaching building ,living building
5	長期 Long term	最少120年 120 + years	城市或其他高要求的建築 Buildings in city or with higher demands

建築金屬圍護 全方位服務

SOLUTION Provider of Metal Building Envelope

性能介紹 2 . Performance

2.2 Wind Resistance 抗風性能

金屬屋面圍護系統建築物經常會遇到強颱風破壞。
The metal building envelop is usually damaged by typhoon.



大自然環境的風力荷載直接影響建築物結構，在迎風面會產生正風壓，屋面和側面會產生負風壓，因此必需要進行充分的設計考慮，防止嚴重的風揭破壞。

The wind load of the natural environment directly affects the structure of the building. Positive wind pressure will be generated on the windward side, and negative wind pressure will be generated on the roof and sides. Therefore, sufficient design considerations must be taken to prevent serious wind damage.

Pressure from wind on windward surfaces

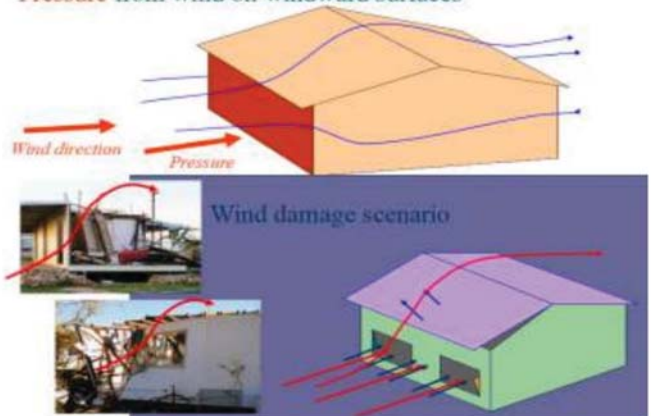

Wind Actions

Forces caused by pressures induced by wind passing over structure

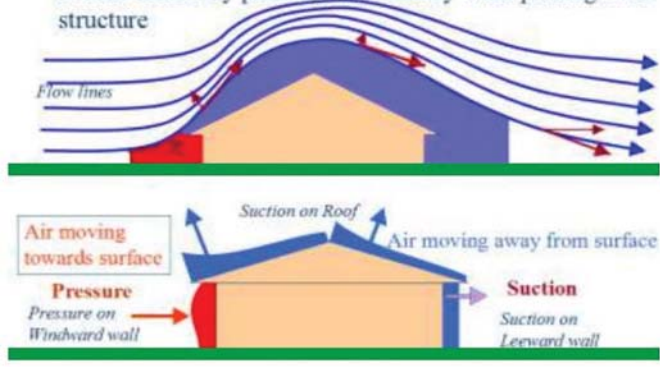

特別注意的是，當自然風從屋面吹過的時候，受負風壓狀態影響，會產生較大的向上拉扯力，由此使得屋面板脫扣，連接失效，進而造成風揭破壞。

It is especially important to note that when the natural wind blows through the roof, a large uplift force will be generated due to the influence of the negative wind pressure, which will cause the roof panel to trip and the connection to fail, thereby causing wind damage.

建築金屬圍護 全方位服務

SOLUTION Provider of Metal Building Envelope

性能介紹 2 . Performance

2.2 Wind Resistance 抗風性能

FASDEK 快易安全屬屋面為有效應對風荷問題通過系統全面的設計考慮。滿足不同地區，不同海拔，不同建築造型對於抗風性能的不同要求。如主支撐間距的合理設置,固定座密度的合理排布等,有效提高其抗風性能。

FASDEK considers comprehensively to meet different requirements of wind resistance for different buildings in different regions , such as reasonable main support span, fixing clips quantity. For example :Rational arrangement of purlins spacing or fixed bearing, effectively improve the performance of wind resistance.

百安力會根據建築設計風壓,初步進行系統設計,然後按照MCIS進行抗風揭檢測,驗證所推薦的屋面系統設計方案,以確保產品抗風安全。

Based on the building design wind pressure, P&L will design the system initially and then take wind resistance test, which is according to MCIS, to verify the solution available.

抗風性能檢測標準 Wind resistance test standard

抗風性能檢測遵循MCIS-PPT-01抗風揭檢測方法進行,抗風檢測方法可分為靜態抗風揭與動態抗風揭檢測。值得注意的是,一個真正的颱風持續時間為13~14個小時,約50000秒,一次波動時間為10秒,為真實模擬台風状态波動風荷載檢測的基礎數值5000次僅為一個颱風週期的模擬。測試風荷載的分級實際上是模擬真實的颱風變化,所以對於動態風荷載檢測可要求至少要高於5000次的檢測。

The wind resistance test is carried out according to the MCIS-PPT-01 wind resistance test method, which can be divided into static wind resistance test and dynamic wind resistance test. It is worth noting that the duration of a real typhoon is 13~14 hours, about 50,000 seconds, and the time of one fluctuation is 10 seconds, which is the basic value of 5,000 times for the real simulation of typhoon state fluctuation wind load detection, which is only a simulation of one typhoon cycle. . The classification of the test wind load is actually to simulate the real typhoon change, so for the dynamic wind load detection, at least 5000 times of detection may be required.

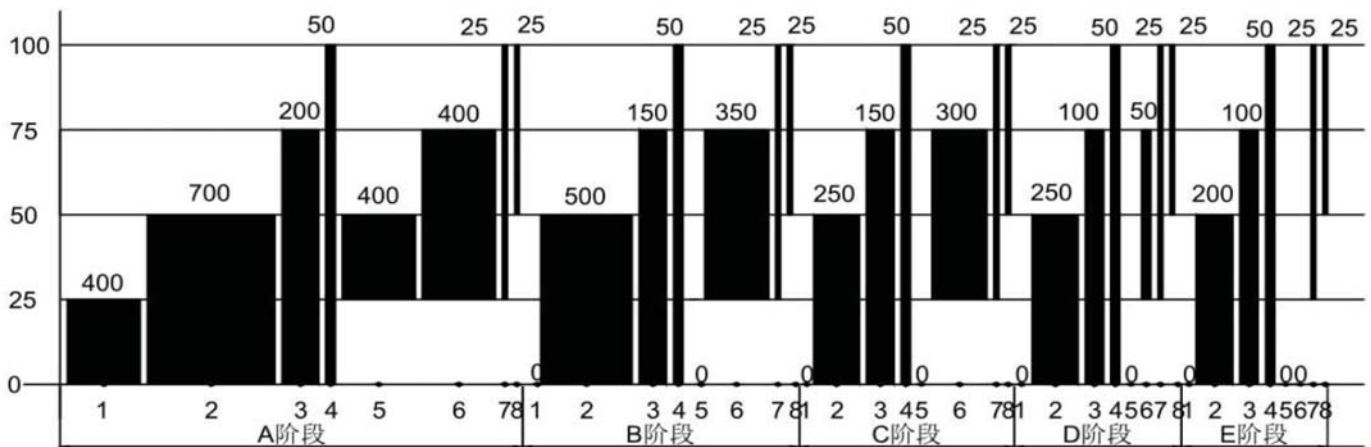

FASDEK 快易安全屬屋面系統達到 MCIS-PPT-01 風荷載要求。

FASDEK metal roof can meet the wind loading resistance requirement of MCIS-PPT-01.

建築金屬圍護 全方位服務

SOLUTION Provider of Metal Building Envelope

性能介紹 2 . Performance

2.3 Water proof 防水性能

金屬屋面系統最常見的便是漏水漏雨問題，而漏水的原因可能是多方面的比如：
Leakage is the most common problem of metal roof system caused by the following reasons:

- 屋面坡度與排板方向
Roof slope and panel laying
- 屋面板的防水排水能力
Waterproofing and draining ability
- 天溝與落水管
Gutter and downpipe
- 搭接與節點處理
Lap details
- 屋面板的強度與剛度性能
Strength and stiffness of roof panel
- 材料的耐用性
Material durability
- 屋面的施工質量
Installation quality



明報 Ming Pao Daily News

FASDEK 快易安全屬屋面充分考慮建築的防水要求，通過不同的防水材料搭配，科學的節點處理，適宜的坡度與板材設置，有效的排水路徑分配，以及專業的施工隊伍來達到有效防水要求。

FASDEK fully considers the construction waterproofing requirements, which including different waterproofing material, scientific node processing, suitable slope and plate laying, effective draining path and professional installing team to achieve effective waterproofing requirement.

Gutter and downpipe design 天溝與落水管設計:

虹吸排水系統：利用屋面與地面所形成的高差間產生的能量，控制排水高度，隔絕空氣進入排水管，以滿管狀態（虹吸狀態）排水時，以抽吸的作用將雨水快速的排走。

Siphon draining system: Prevent air getting into draining pipe by the height difference roof and ground, siphoning the rainwater speedily.

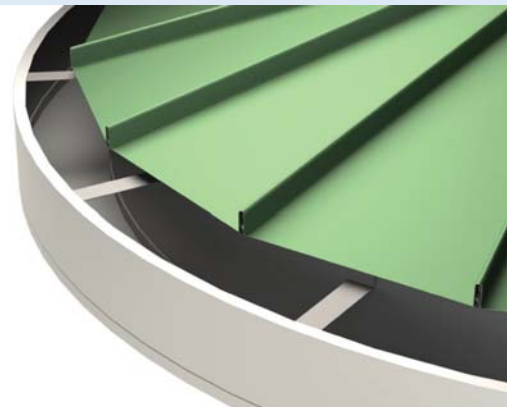
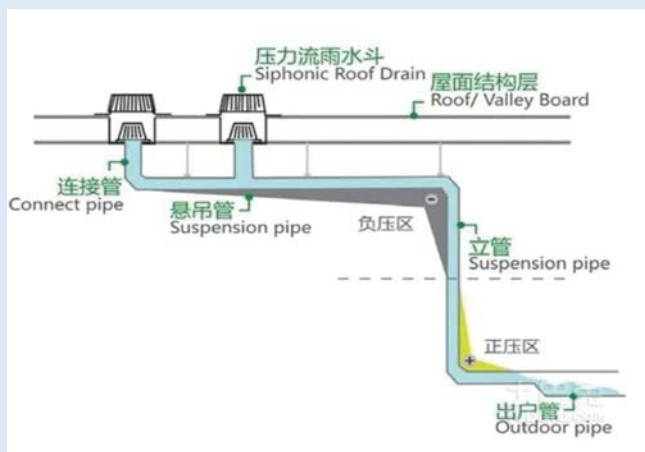

建築金屬圍護 全方位服務

SOLUTION Provider of Metal Building Envelope

性能介紹 2 . Performance

2.3 Waterproof 防水性能

為確保屋面產品的防水性能,P&L百安力同樣提供嚴謹的檢測驗證服務,按照MCIS標準執行屋面噴淋試驗驗證,所推薦的金屬屋面系統防水性能可靠。

In order to ensure the waterproof performance of roofing products, P&L Baianli also provides testing and verification services, and performs roof spray test verification in accordance with MCIS standards. The recommended metal roofing system has reliable waterproof performance.

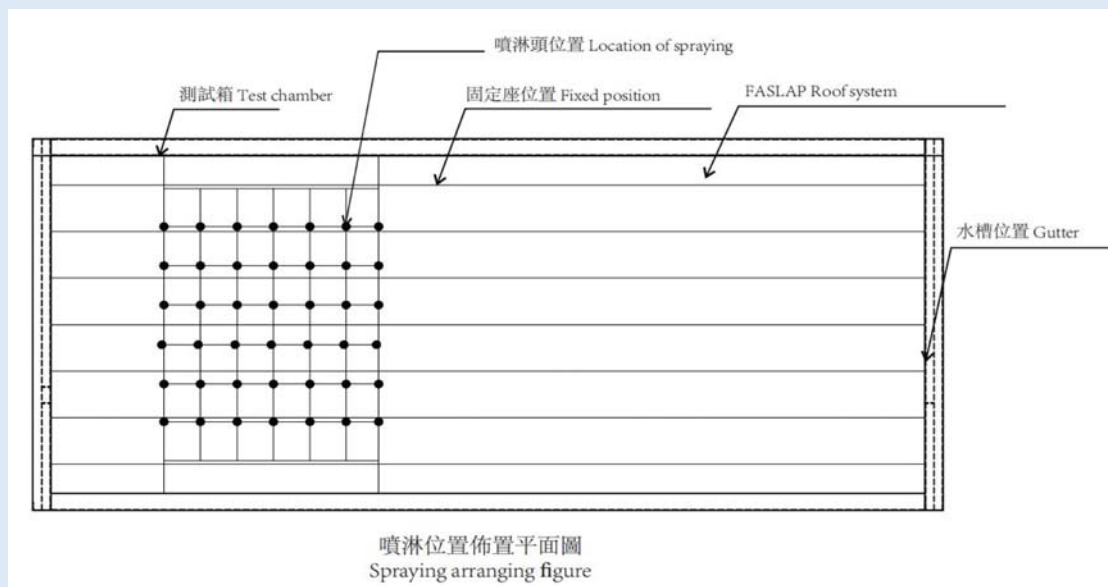

模擬真實風雨狀態 Simulating real storm :

金屬屋面在強風雨的天氣狀態下,屋面金屬板接縫會受風壓的影響產生鬆動進而導致雨水滲漏,因此在FASEAL 快易封屋面系統進行模擬噴淋降雨實驗時加入了風壓作用,測試階段如下表:

In the weather of strong wind and rain, the metal roof joints will be loose due to the influence of wind pressure, which will lead to the leakage of rainwater. Therefore, the effect of wind pressure was added to the simulated spray rainfall experiment of the FASEAL roofing system. The test phase is as follows:

載入階段 Loading stage	目標壓力值(Pa) Target pressure	保壓(sec) Remaining time	卸載時間(min) Unloading time
1	-3225	10	2
2	-4300	10	2
3	-3225	10	2
4	-4300	10	2
5	-3225	10	2
6	-4300	10	2

建築金屬圍護 全方位服務

SOLUTION Provider of Metal Building Envelope

2.4 Fire Resistance 耐火性能



金屬屋面防火設計應遵循的最高原則：

The highest principle of fire resistanting design :

有效的防止火災快速的蔓延，在建築結構失效前，確保人員有充足的時間逃離火災現場。各地耐火標準對此各有不同，一般為60min-90min。

Effectively prevent the rapid spread of fire, and ensure that personnel have sufficient time to escape the fire scene before the building structure fails. The fire resistance standards vary from place to place, generally 60min-90min.

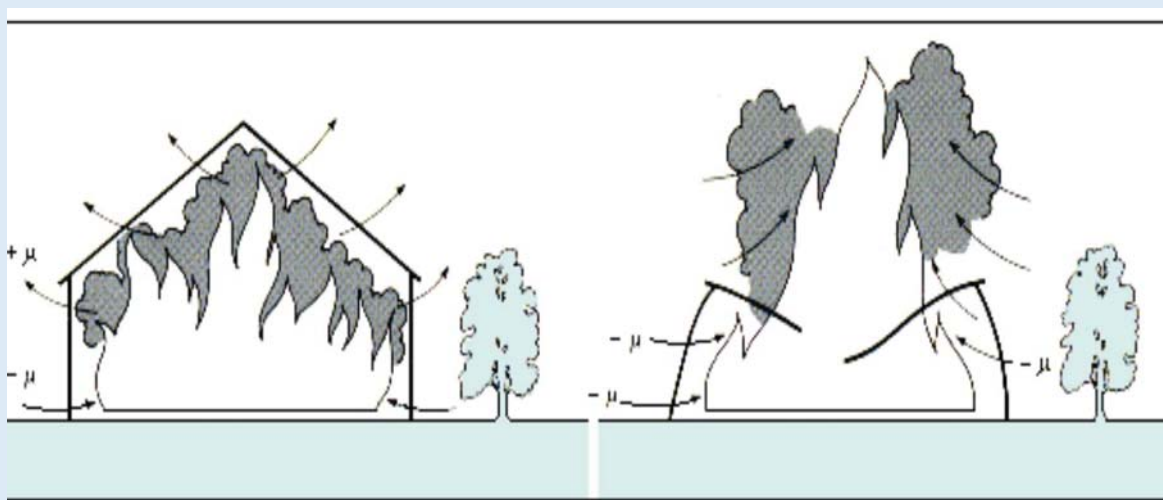

建築金屬圍護 全方位服務

SOLUTION Provider of Metal Building Envelope

性能介紹 2 . Performance

2.4 Fire Resistance 耐火性能

為保證屋面產品應用的耐火性能安全,參考英國標準的耐火檢測方法,對屋面系統試件進行試驗,確定產品在要求的測試時間內無燒穿,無融化。

In order to ensure the safety of the fire resistance performance of the roofing product application, refer to the British standard fire resistance test method to test the roof system specimens to ensure that the product does not burn through or melt within the required test time.

耐火檢測方法示意:

Fire resistanting test :

試件尺寸 Specimen size	輻射距離 Radiation distance
1M*1M	585mm ± 5mm
輻射量 Radiation quantity	輻射角度 Radiation angle
2 ± 1.5Kw/ m ²	0° / 45°

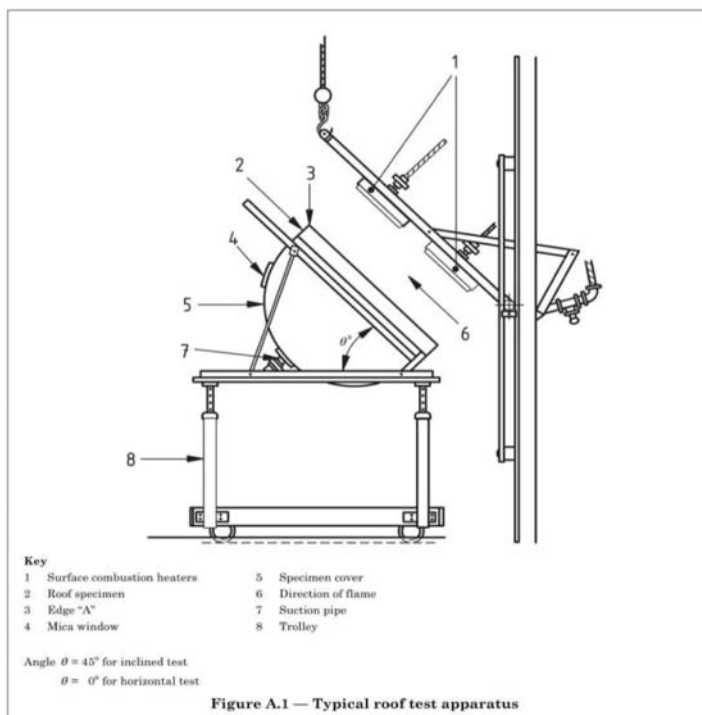

FASDEK 快易安全屬屋面系統材料本身屬於A1級不燃材料外,還可以根據建築設計的不同耐火要求進行靈活合理的系統組件調整,以滿足應用要求。

In addition to the materials themselves are A1 non-combustible materials, the FASDEK metal roofing system can also be adjusted flexibly and reasonably according to the different fire resistance requirements of the building design to meet the application requirements.

檢測結論 Conclusion

5 min	30 min	60 min	90 min
無明顯變化 No obvious change	輕微變黃 Slightly yellowing	局部發黑 Going black partly	輕微變形無燒穿無融化 Deformation slightly without burn through and melting

建築金屬圍護 全方位服務

SOLUTION Provider of Metal Building Envelope

系統節點 3 . Details

3.1 Gable details 山輪節點

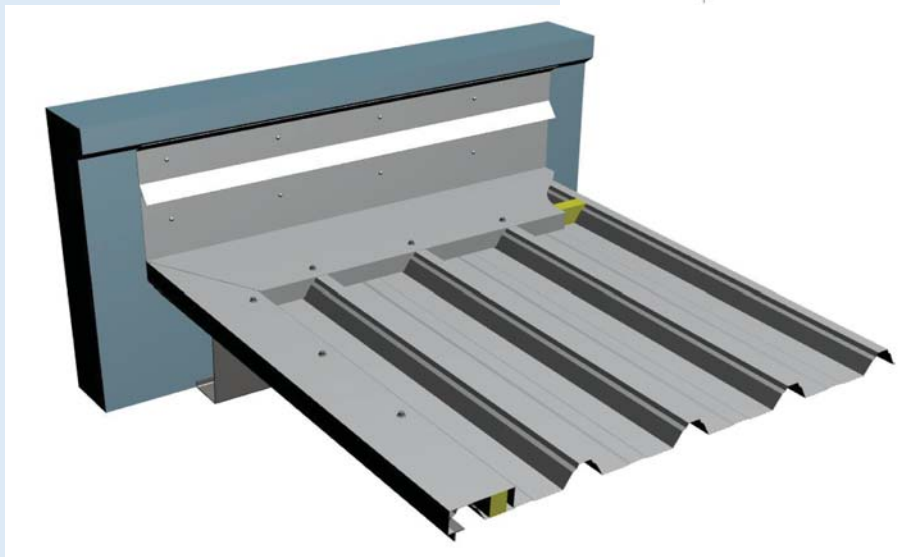
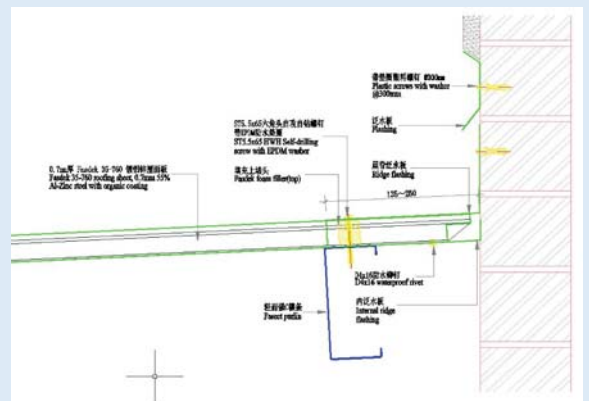
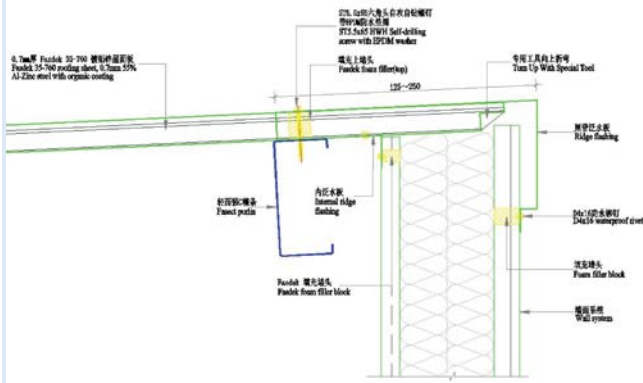

建築金屬圍護 全方位服務

SOLUTION Provider of Metal Building Envelope

系統節點 3 . Details

3.2 Ridge details 屋脊節點

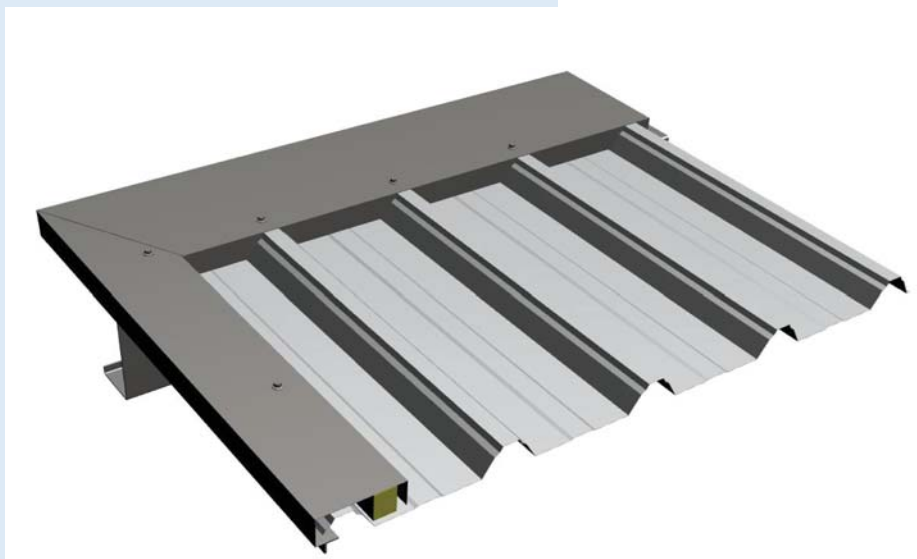
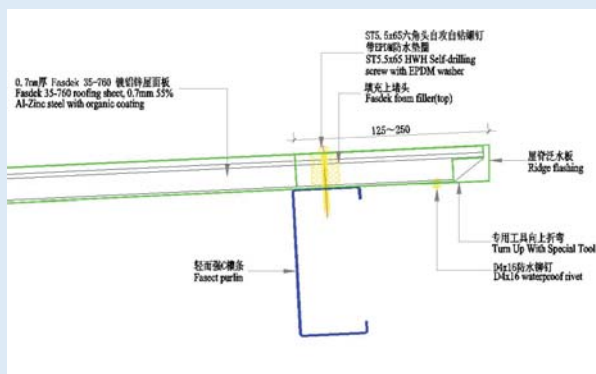
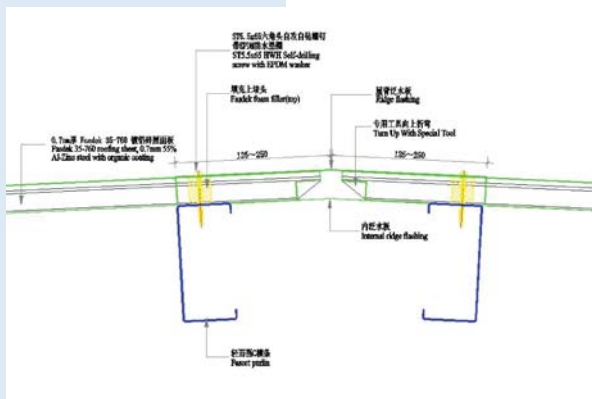
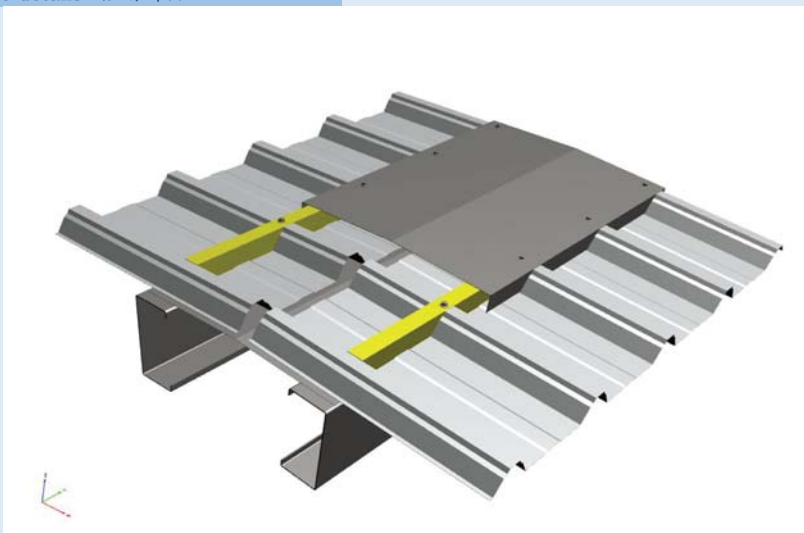

建築金屬圍護 全方位服務

SOLUTION Provider of Metal Building Envelope

工程案例
4 . Projects



建築金屬圍護 全方位服務

SOLUTION Provider of Metal Building Envelope

FASDEK[®] 快易安

波紋式屋面系統

Corrugated Roof System



百安力鋼結構應用科技有限公司
P&Ls Steel Structures Applied Technology Co., Limited

香港新界屯門杯渡路99號工作室5樓506室

Unit 506, 5/F, 99-COMMONS, 99 Pui To Road, Tuen Mun, N.T., HK

Tel : (852) 2451 8882 Email : info@baianli.com.hk / failau@baianli.com.hk

中國廣東省珠海市金灣區三灶鎮卓越路七號

No.7, Zhuoyue Road, Sanzao Town, Jinwan District, Zhuhai City, Guangdong, China

建築金屬圍護 全方位服務

SOLUTION Provider of Metal Building Envelope

www.baianli.com.hk